









KENMERKEN / FEATURES / MARKMALE

	M-250DL27 4WD/P/N
H (max.)	± 27,0 m
A (max.)	± 25,0 m
C (min.)	± 2,5 m
Dx F (min.)	6,15 x 2,50 m
Ex F (max.)	8,25 x 2,50 m
H1	3,89 m
H2	3,13 m
LxB	6,57 x 2,65 m
E	4,50 m
M	395 mm
∅ D	± 7,65 m
 (max.)	1000 kg (4 pers. + 680kg)
 (max.)	1000 kg (4 pers. + 680kg)
 (sec.)	120/105 sec.
	4,2 km/h
	0,5 km/h
	15 x 19,5
 (max.)	± 30%
	Deutz BF4120011
	21.000 kg

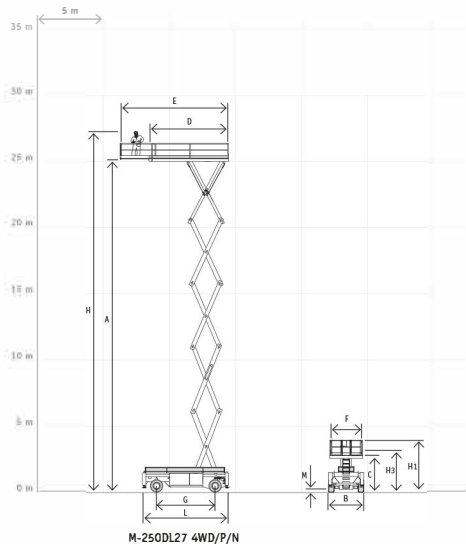

NEDERLANDS	ENGLISH	DEUTSCH	
OPTIES	OPTIONS	OPTIONEN	
Besturing met snelsluutekker	Controlbox with quickdisconnect	Plattformschaltung mit Schnellstecker	●
Urenteller	Hourmeter	Stundenzähler	●
230V voeding op het platform	230V supply on the platform	230V Versorgung an der Plattform	○
Generator 230V	Generator 230V	Generator 230V	○
Rijden op volle hoogte	Driving at full height	Fahren in voller Höhe	○
Rijden, proportioneel	Driving, proportional	Fahren, proportional	●
Sperfunctie	Differential lock	Differentialsperre	●
Vierwiel aandrijving (4WD)	Fourwheel drive (4WD)	Allradantrieb (4WD)	●
Pendelach (P)	Oscillating axle (P)	Pendelachse (P)	●
Nivelleerstempels (N)	Leveling jacks (N)	Nivellierstützen (N)	●
Smeersysteem (Easy Lube, Auto Lube)	Lubrication system (Easy Lube, Auto Lube)	Schmiersystem (Easy Lube, Auto Lube)	○
VEILIGHEIDSVORZIENINGEN	SAFETY FEATURES	SICHERHEITSEINRICHTUNGEN	
Beschermhek	Scissor skirt	Schutzgitter	●
Rij-alarm (akoestisch)	Drive alarm	Fahrwarnung (akustisch)	●
Nooddalvoorziening	Emergency descent	Nothenvorrichtung	●
TOEPASSING	APPLICATION	ANWENDUNG	
Voor gebruik in gesloten ruimten	Indoors	In geschlossenen Räumen	●
Voor gebruik buiten	Outdoors	Im Freien	●
Toelaatbare min. omgevings temperatuur	Certified min. temperature	Zul. tiefsttemperatur	-15°C

NOTITIES / NOTES / NOTIZEN



HOLLAND LIFT

Holland Lift International B.V.

Anodeweg 1













NL-1627 LJ Hoorn

The Netherlands

Tel: +31 (0) 229 285555

Fax: +31 (0) 229 285550

E-mail: info@hollandlift.com

H (max.)	Werkhoogte Working height Arbeitshöhe
A (max.)	Max. platformhoogte Max. platform height Max. Plattformhöhe
C (min.)	Min. platformhoogte Min. platform height Min. Plattformhöhe
Dx F (min.)	Platform afmetingen (ingeschoven) Platform dimensions (retracted) Plattformgröße (eingeschoben)
Ex F (max.)	Platform afmetingen (uitgeschoven) Platform dimensions (extended) Plattformgröße (ausgeschoben)
H1	Transporthoogte Transport height Transporthöhe
H2	Transporthoogte (handrail verwijderd) Transport height (handrail removed) Transporthöhe (Geländer entfernt)
H3	Transporthoogte (handrail neergeklapt) Transport height (handrail folded down) Transporthöhe (Geländer umgeklappt)
LxB	Transportafmetingen Transport dimensions Transportabmessungen
G	Wielbasis Wheelbase Radstand
K	Trackbreedte Track width Raupenbreite
M/N	Bodemvrijheid Ground clearance Bodenfreiheit
∅ D	Braaicirkeluitwendig Turning radius outside Wendradius Außen
 (max.)	Max. belasting platform (ingeschoven) Capacity main-platform (retracted) Tragfähigkeit Plattformfestteil
 (max.)	Max. belasting platform (uitgeschoven) Capacity roll-out deck Tragfähigkeit Plattformauschub
 (sec.)	Heff/daaltijd (max. last) Lift-/lower time (max. load) Hebe-/Senkzeit (max. Traglast)
	Rijsnelheid (snel) Driving speed (high) Fahrtgeschwindigkeit (schnell)
	Rijsnelheid (langzaam) Driving speed (slow) Fahrtgeschwindigkeit (langsam)
	Banden, non marking (volrubber) Tyres, non marking (solid rubber) Reifen, non marking (Vollgummi)
	Banden, terrein (schuimgevoeld) Tyres, terrain (foam feel) Reifen, Gelände (ausgeschäumt)
	Banden, tractor (schuimgevoeld) Tyres, tractor (foam feel) Reifen, Traktor (ausgeschäumt)
	Vlakstellen links/rechts (dwars) Leveling left/right (transversal) Quer nivellieren (links/rechts)
 (max.)	Max. klimvermogen Gradeability Max. Steigfähigkeit
	Batterijcapaciteit (natte cellen) Batteries (traction acid) Batteriekapazität (Traktion Nasszellen)
	Dieselmotor Diesel engine Dieselmotor
 KG	Eigenegewicht Gross weight Eigengewicht
●	Standaard Standard Standardausrüstung
○	Optie Option Option
---	Niet beschikbaar Not available Nicht verfügbar

V36



Unit A12/A13
Kenyon Court
Walter Leigh Way
Moss Industrial Estate
Leigh, WN7 3PT

APL

AERIAL PLATFORMS

0800 085 3709



info@aerialplatforms.co.uk

