

# 120 AETJ-C

TECHNICAL DATA SHEET

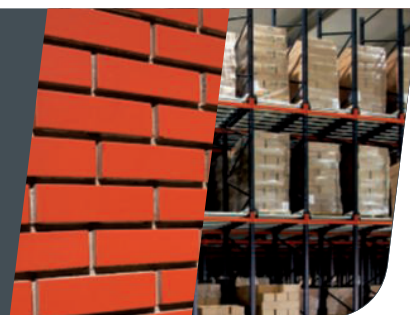

 **MANITOU**  
www.manitou.com









**APL**  
AERIAL PLATFORMS

**0800 085 3709**  
[WWW.AERIALPLATFORMS.CO.UK](http://WWW.AERIALPLATFORMS.CO.UK)

**HIRE NOW!**

Aerial Platforms Ltd, Denebrook Court, Greenfold Way, Leigh, WN7 3XJ

# 120 AETJ-C

		120 AETJ-C
	<b>Working height</b>	11.95 m
	<b>Platform height</b>	9.95 m
	<b>Articulation height</b>	4.77 m
	<b>Outreach</b>	7.00 m
	<b>Jib tilting</b>	+70° / -70°
	<b>Jib Movement</b> (option 3D)	+70° / -70°
	<b>Basket rotation</b>	140°
	<b>Turret rotation</b>	355°
	<b>Capacity</b>	200 kg
	<b>Number of persons</b> (indoor/outdoor)	2/2
	<b>Basket</b> (width and length)	1.20 x 0.92 m
	<b>1. Overall width</b>	1.20 m
	<b>2. Overall length</b>	5.48 m
	<b>3. Overall height</b>	1.99 m
	<b>4. Overall length when folded</b>	3.74 m
	<b>5. Overall height when folded</b>	2.16 m
	<b>6. Interior turning circle</b>	1.55 m
	<b>7. Exterior turning circle</b>	3.25 m
	<b>8. Exterior turning circle</b> (option 3D)	3.44 m
	<b>9. Ground clearance</b>	10 cm
<b>10. Wheelbase</b>	1.65 m	
	<b>Speed of forward movement</b>	6 kph
	<b>Working speed</b>	0.60 kph
	<b>Maximum slope accessible</b>	25 %
	<b>Maximum tilt</b>	5 % / 3°
	<b>Tyres</b>	0.60 x 0.19 m
	<b>Driving wheels</b>	2 (back)
	<b>Steering/directional wheels</b>	2 (front)
	<b>Weight</b>	6660 kg
	(varies according to options & standards of the country)	
	<b>Batteries</b>	240 Ah / 2 x 24 V
	<b>Integrated charger</b>	30 Ah / 48 V

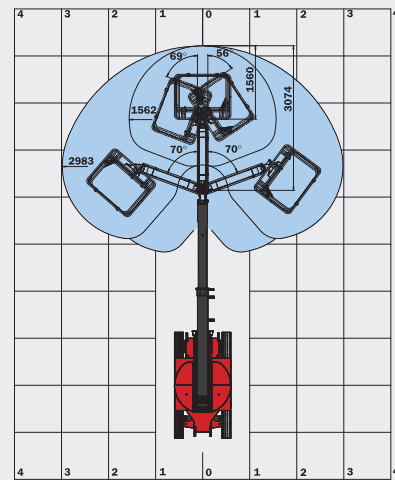
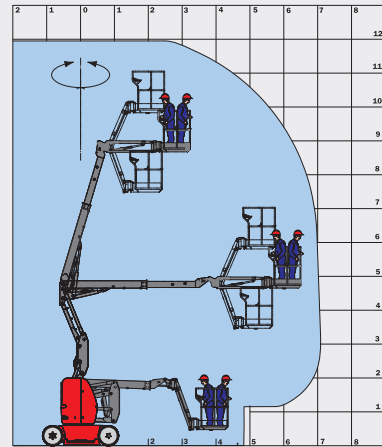

Option 3D: Jib Movement

## Standard equipment

- Proportional switches/levers
- Forward movement possible at maximum height
- Sound and visual alarm in case of excessive slant and overload
- Integrated charger
- Emergency manual descent
- Negative braking system
- Sound warning system inside the platform
- Hour meter
- Indication of state of charge of batteries
- Hooks for sling loading/lifting
- Integrated diagnostic aid
- Predisposition 220V
- Anti Roll System
- Tyres with non-marking edges
- Basket with transparent floor
- Bus CAN technology
- Tool box inside platform

## Optional equipment

- Flashing lights
- Working light
- Predisposition of air
- Predisposition of water
- 230V power input with differential circuit-breaker
- Special paint
- Biodegradable oil
- Rotation of pendulum arm (3D)
- High capacity battery (300 Ah / 2 x 24 V)
- Central topping up of batteries
- Warning signal moving forward
- Warning signal for all movements
- Protective cover for instruments panel
- Initial certificate of verification prior to entry into service
- Safety harness

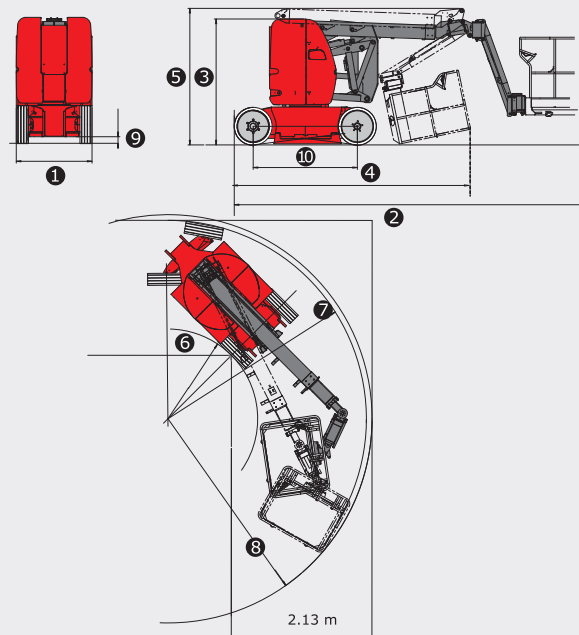

0800 085 3709

WWW.AERIALPLATFORMS.CO.UK

**HIRE NOW!**